

# Series W-STBV-25Q

W-STBV-25Q-EN-202010

## Static Balancing Valve

### Size: DN65-DN500

The Series W-STBV static balancing valves are designed for flow balancing in cooling, heating or process water systems. Its measuring points enable convenient system troubleshooting.

### Features

- Accurate flow control
- Numerical indicator of opening degree on the hand wheel
- Lockable set position
- Shut-off function for troubleshooting or maintenance
- Self-sealing measuring points to protect against leakage
- Using balanced valve core, easy to adjust
- The hand wheel adopt the die casting aluminum, strong and durable
- The hand wheel wrench connection with energy saving



### Material

NO.	Component	Material
1	Body	Ductile Iron GGG40
2	Core	Ductile Iron GGG40
3	Seat Sealing	EPDM
4	Shaft Barrel	DN65-150 Brass HPb59-1 DN200-500 Ductile Iron GGG40
5	Stem	Brass HPb59-1
6	Limit Valve Core	Brass HPb59-1
7	Cover	Ductile Iron GGG40
8	Handwheel	DN65-300 Nylon 66 DN350-500 Ductile Iron GGG40
9	Measuring Mouth	Brass HPb59-1

### Specification

- Nominal Pressure: PN25
- Working Temperature: -10~120°C
- Connect Standard: GB/T 17241.6, ISO7005
- Working Medium: cold and hot water/ethylene glycol

### Product Model

Type	Size	Kvs	EDP
W-STBV065-25Q	DN65	92.7	61170004
W-STBV080-25Q	DN80	114.5	61170005
W-STBV100-25Q	DN100	187.5	61170006
W-STBV125-25Q	DN125	286.5	61170007
W-STBV150-25Q	DN150	395.0	61170008
W-STBV200-25Q	DN200	758.0	61170009
W-STBV250-25Q	DN250	1102.5	61170010
W-STBV300-25Q	DN300	1516.6	61170011
W-STBV350-25Q	DN350	2115.0	61170012
W-STBV400-25Q	DN400	3050.0	61170013
W-STBV450-25Q	DN450	3720.0	61170014
W-STBV500-25Q	DN500	4180.0	61170015

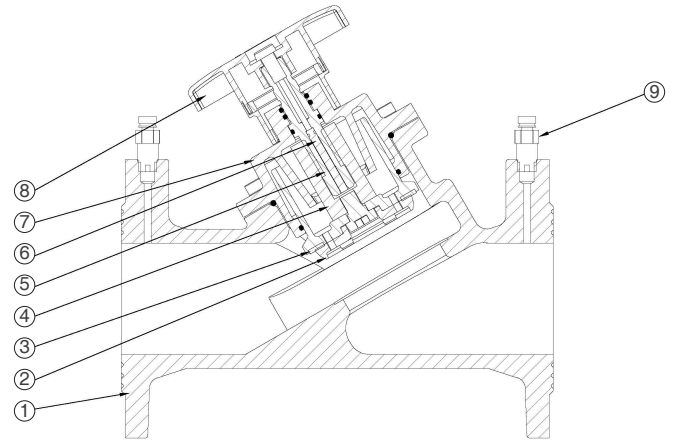

### Kv Value Curve

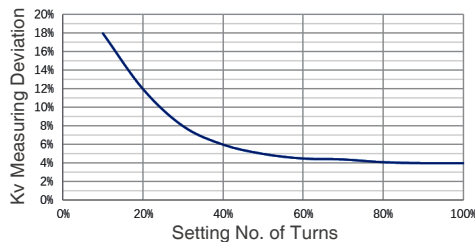

### Product Type

W	WATTS	W-	STBV	065-	25	Q
STBV	Static Balancing Valve					
Size						
065-DN65	080-DN80					
100-DN100	125-DN125					
150-DN150	200-DN200					
250-DN250	300-DN300					
350-DN350	400-DN400					
450-DN450	500-DN500					
Pressure	PN25					
Body Material	Ductile Iron					

Watts reserves the right to change or modify product design, construction, specifications, or materials without prior notice and without incurring any obligation to make such changes and modifications on Watts products previously or subsequently sold.



### Kvs

Turns	DN65	DN80	DN100	DN125	DN150	DN200	DN250	DN300	DN350	DN400	DN450	DN500
1	15.5	16.3	26.0	22.0	27.9	67.0	109.0	128.0	167.2	208.0	240.5	305.2
2	32.5	32.2	45.0	53.0	54.9	127.0	184.0	211.1	240.0	344.0	396.5	518.0
3	48.7	52.5	59.0	74.0	76.8	191.0	264.0	290.3	330.0	452.0	548.0	724.0
4	58.1	67.5	69.0	96.0	97.6	278.0	356.0	350.6	485.0	651.0	749.0	1024.0
5	64.4	77.2	95.0	125.0	117.2	388.7	438.8	481.2	658.0	824.0	915.0	1315.0
6	69.2	86.2	127.0	156.0	143.2	474.3	538.6	624.2	824.0	1054.5	1242.0	1592.0
7	74.9	96.4	144.5	193.0	186.5	558.7	661.7	731.0	1045.0	1380.0	1541.0	1890.0
8	83.1	104.7	166.5	226.0	225.2	638.1	770.0	886.9	1215.0	1542.0	1792.0	2142.0
9	92.7	114.5	187.5	253.2	265.9	719.5	826.7	1042.1	1420.0	1765.0	2046.0	2586.0
10				286.5	321.5	758.0	920.0	1177.3	1685.0	1980.0	2425.0	2845.0
11					362.6		1010.0	1330.1	1824.0	2220.0	2680.0	3192.0
12					395.0		1102.5	1429.1	1988.0	2480.0	2880.0	3480.0
13								1516.6	2115.0	2620.0	3180.0	3640.0
14										2750.0	3350.0	3892.0
15										2940.0	3580.0	4024.0
16										3050.0	3720.0	4180.0

### Installation Dimensions

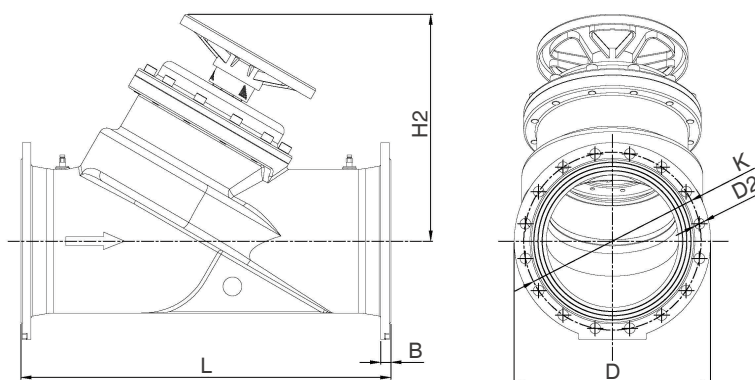

Type	B(mm)	K(mm)	D2(mm)	D(mm)	L(mm)	H2(mm)	Weight(Kg)
W-STBV065-25Q	19	145	8-19	185	290	200	15.5
W-STBV080-25Q	19	160	8-19	200	310	210	20
W-STBV100-25Q	19	190	8-23	235	350	246	26
W-STBV125-25Q	19	220	8-28	270	400	256	38
W-STBV150-25Q	20	250	8-28	300	480	286	52
W-STBV200-25Q	22	310	12-28	360	600	460	99
W-STBV250-25Q	24.5	370	12-31	425	730	493	146
W-STBV300-25Q	27.5	430	16-31	485	850	535	200
W-STBV350-25Q	30	490	16-34	555	980	595	321
W-STBV400-25Q	32	550	16-37	620	1100	635	438
W-STBV450-25Q	34.5	600	20-37	670	1200	688	589
W-STBV500-25Q	36.5	660	20-37	730	1250	745	705

### Characteristic Curves

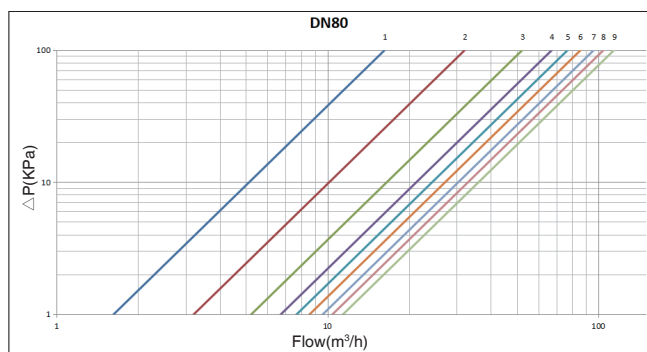
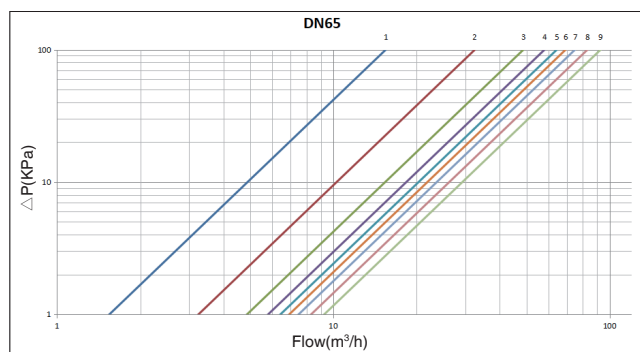

Watts reserves the right to change or modify product design, construction, specifications, or materials without prior notice and without incurring any obligation to make such changes and modifications on Watts products previously or subsequently sold.



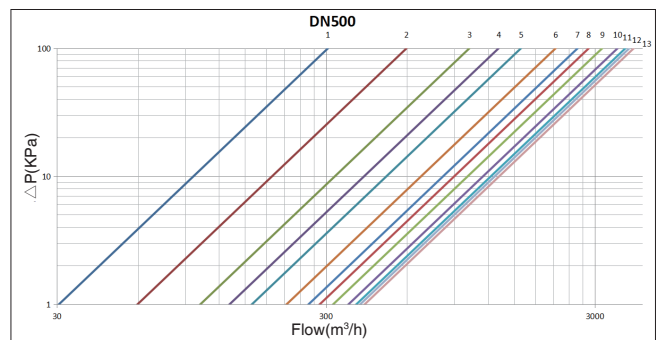
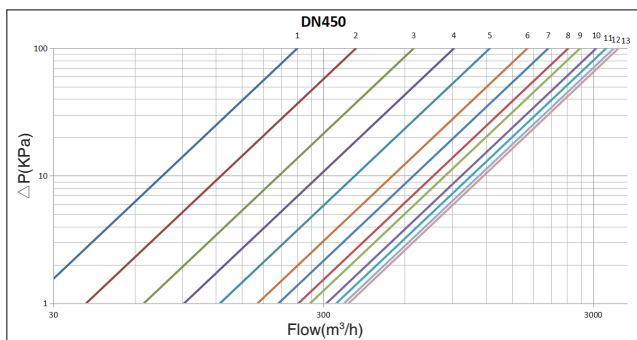
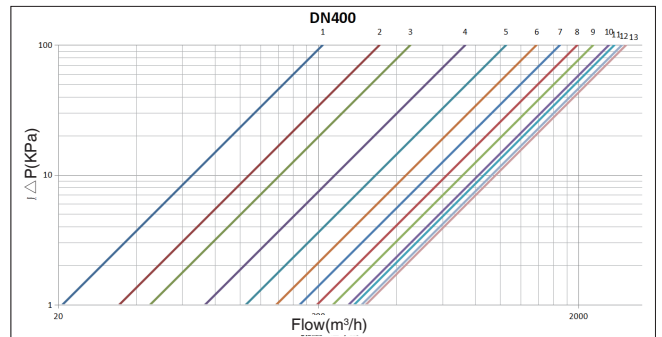
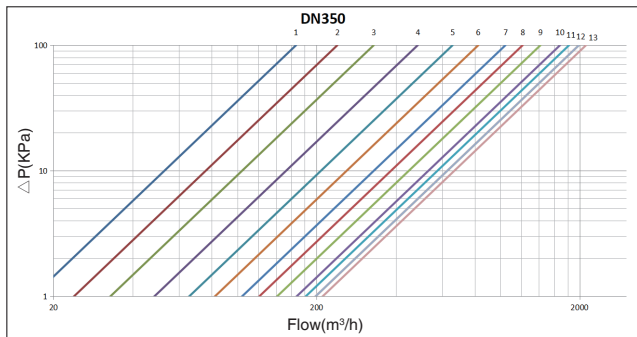
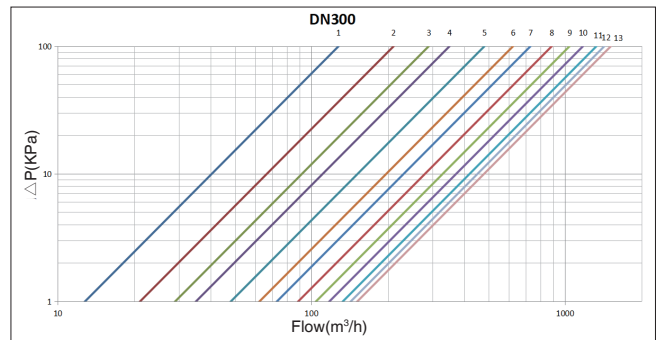
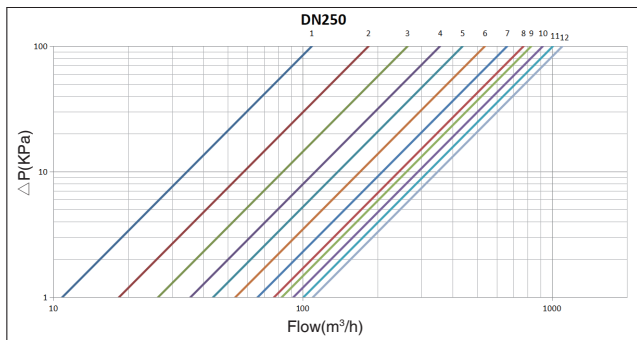
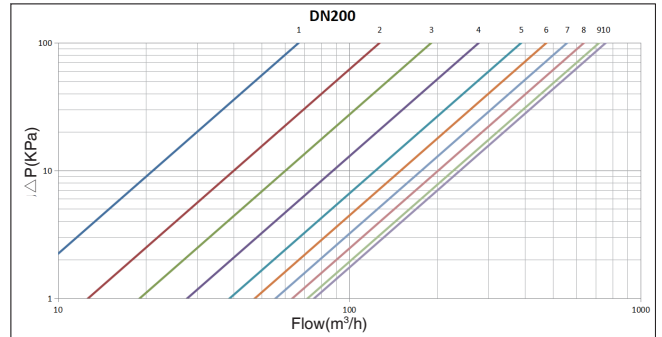
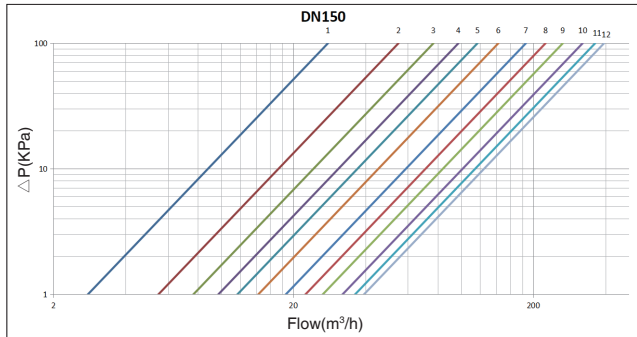
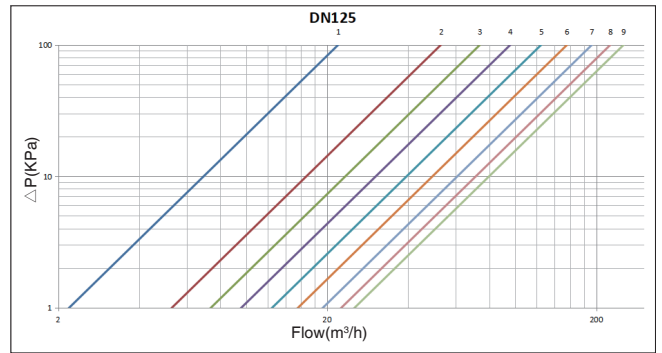
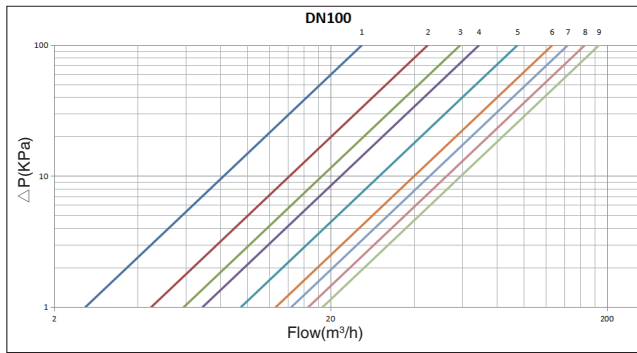

Watts reserves the right to change or modify product design, construction, specifications, or materials without prior notice and without incurring any obligation to make such changes and modifications on Watts products previously or subsequently sold.



## Selection Drawing

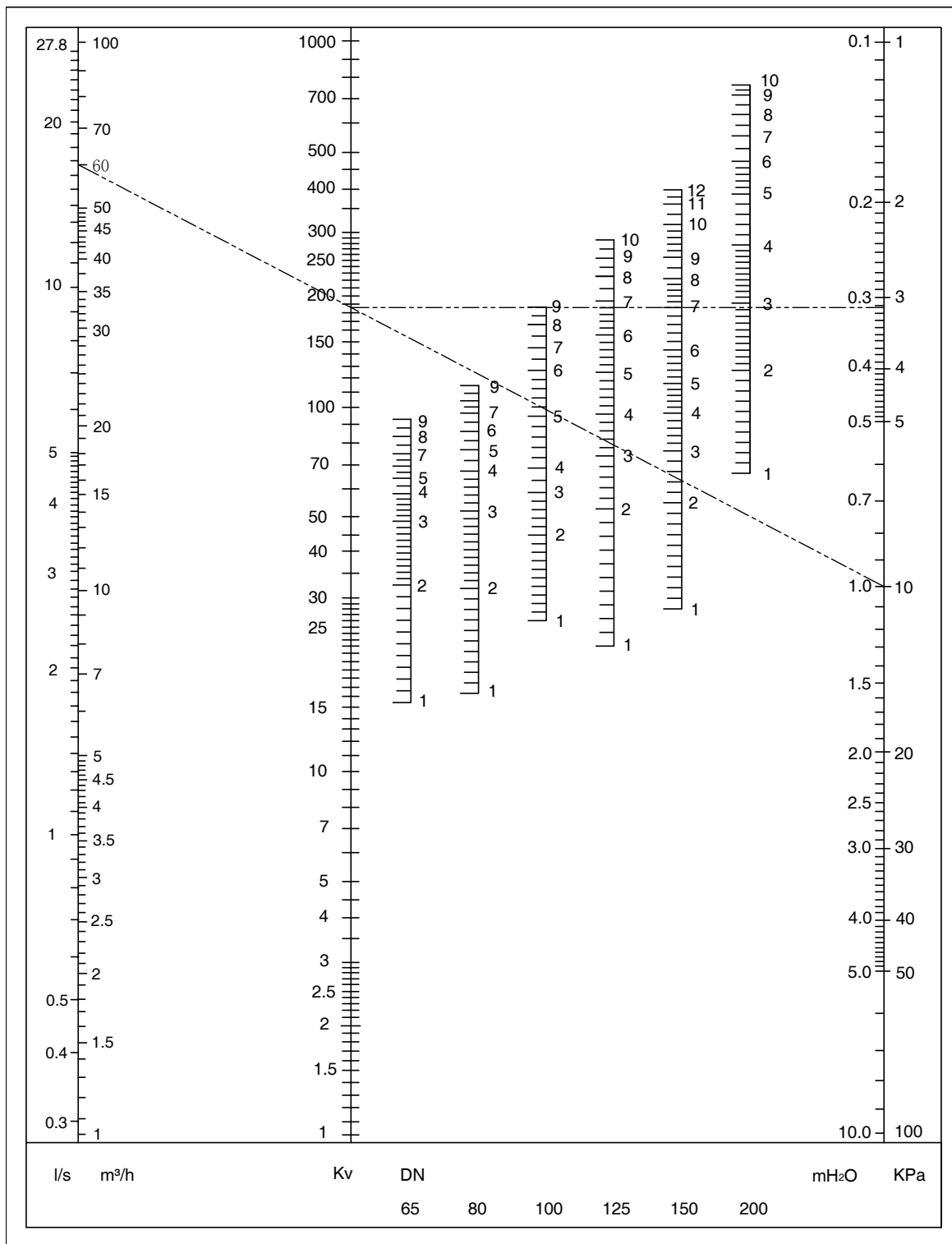

Watts reserves the right to change or modify product design, construction, specifications, or materials without prior notice and without incurring any obligation to make such changes and modifications on Watts products previously or subsequently sold.



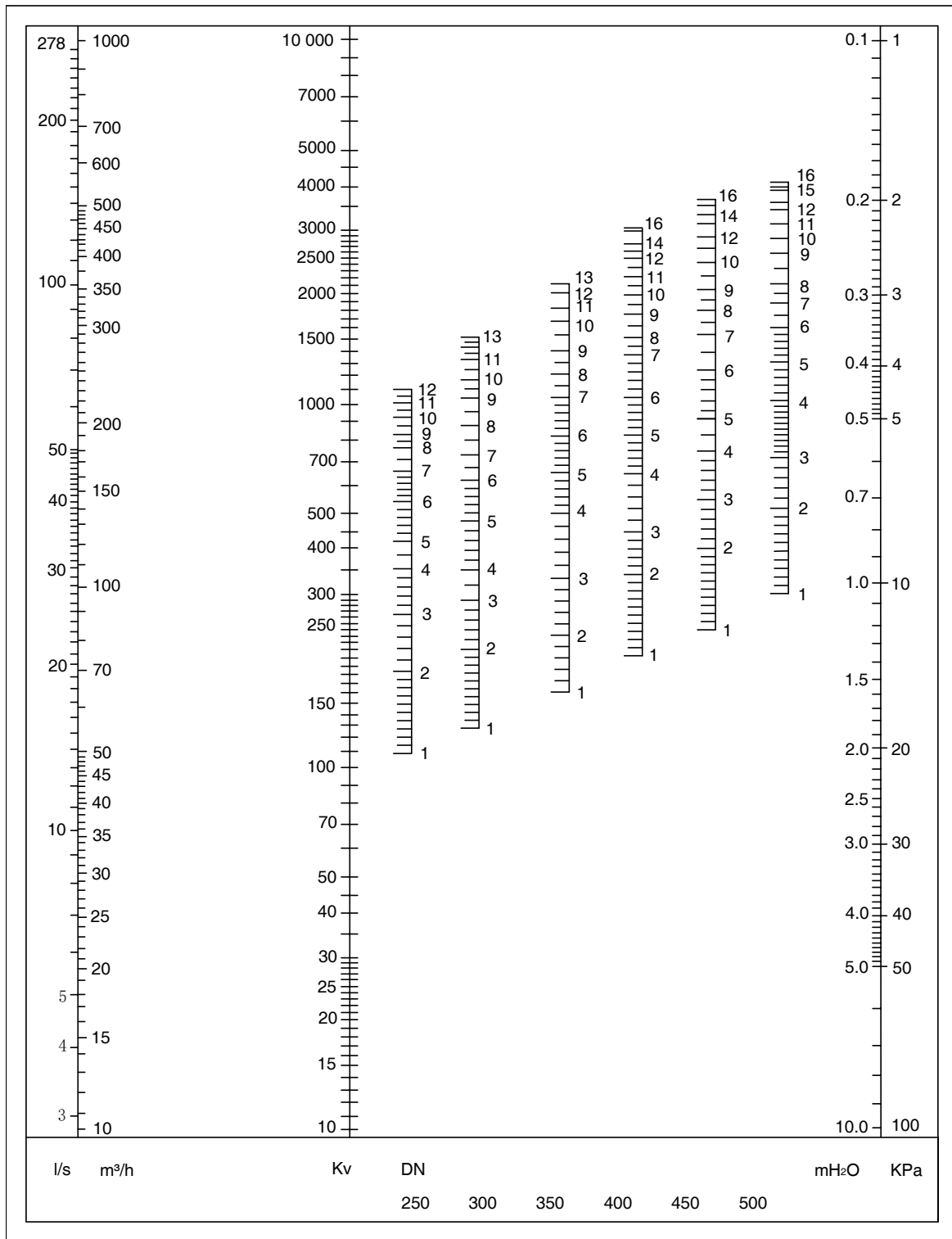

Watts reserves the right to change or modify product design, construction, specifications, or materials without prior notice and without incurring any obligation to make such changes and modifications on Watts products previously or subsequently sold.

